

P1=P2=P3=P4=P5=P6=P7=P8=P41=P42=P43=P44  
 =P45=P46=P47=P48=P49=P50=P51=P52=P53  
 =P54=P55=P56=P107=P108=P109=P110=P111  
 =P112=P113=P114

P10=P11=P14=P15=P18=P19=P20=P21=P22=P26101  
 =P27=P28=P30=P31=P34=P35=P38=P39=P64  
 =P65=P71=P74=P75=P78=P80=P82=P87=P88  
 =P104=P105

P102

P103

P12=P13

P23=P63

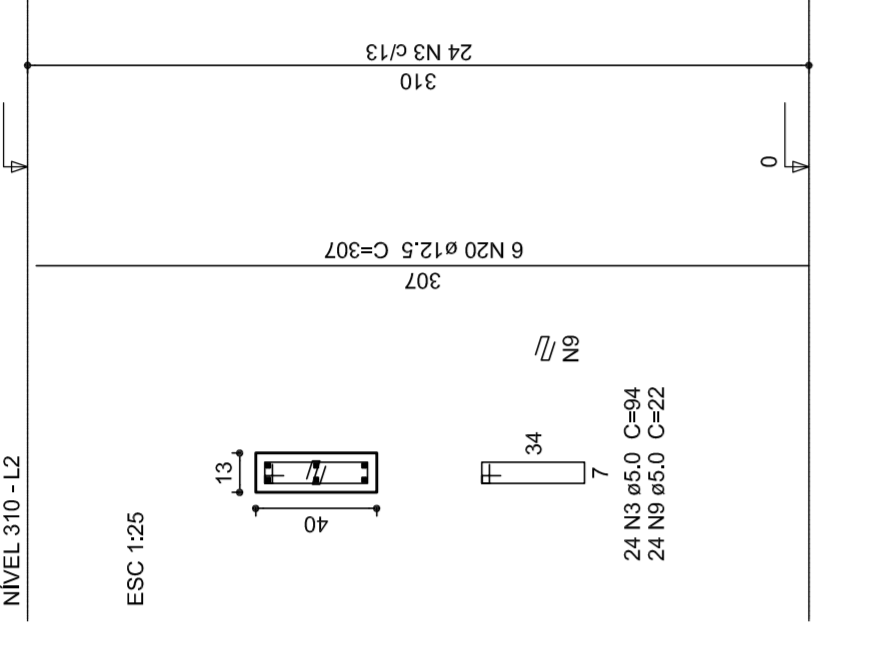
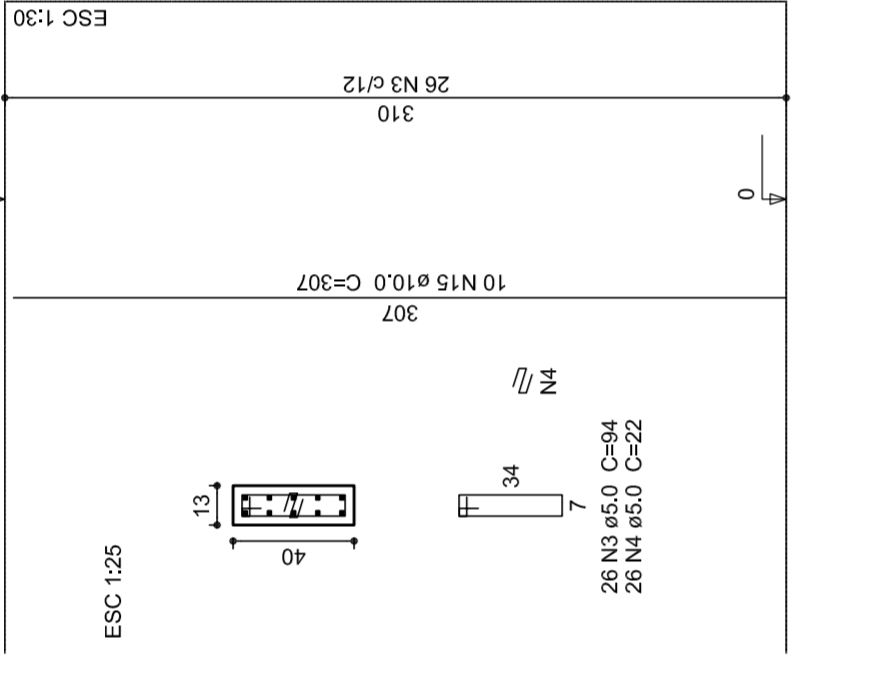
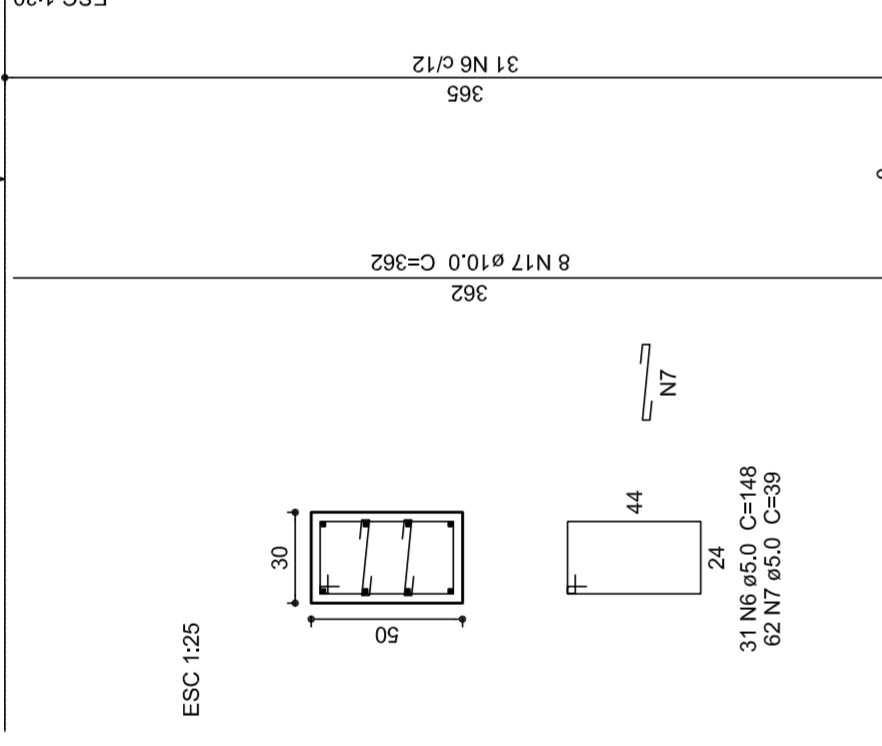
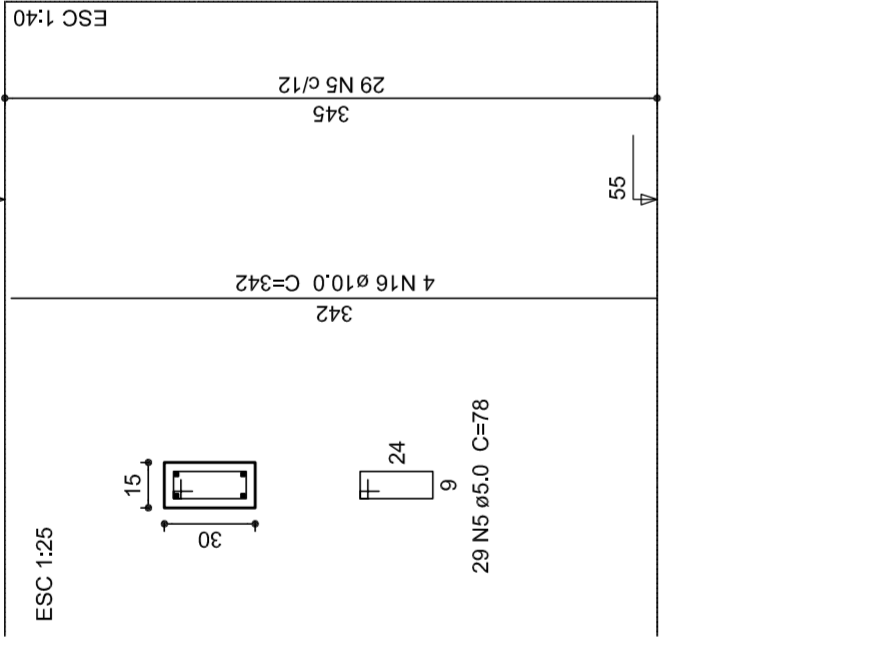
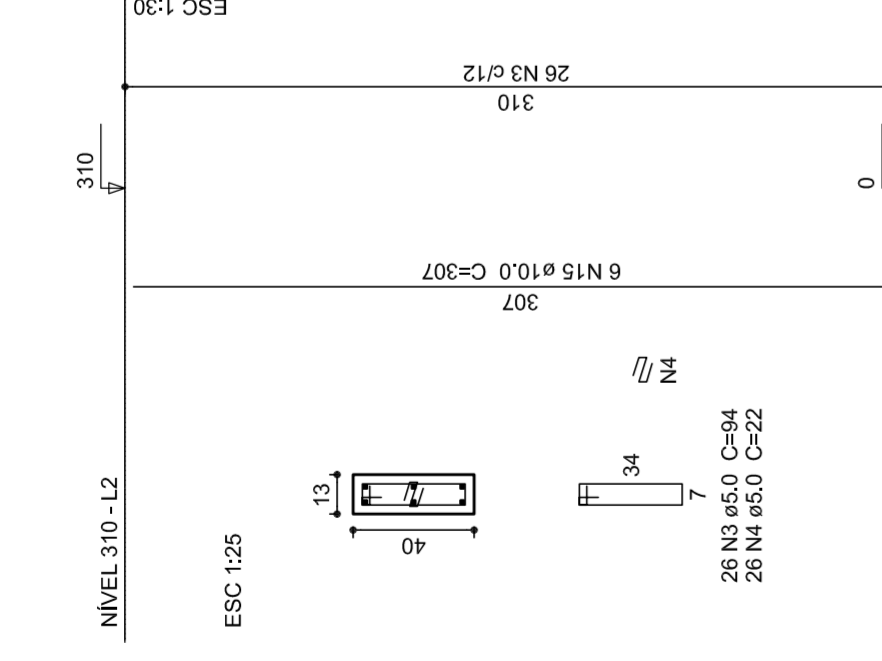
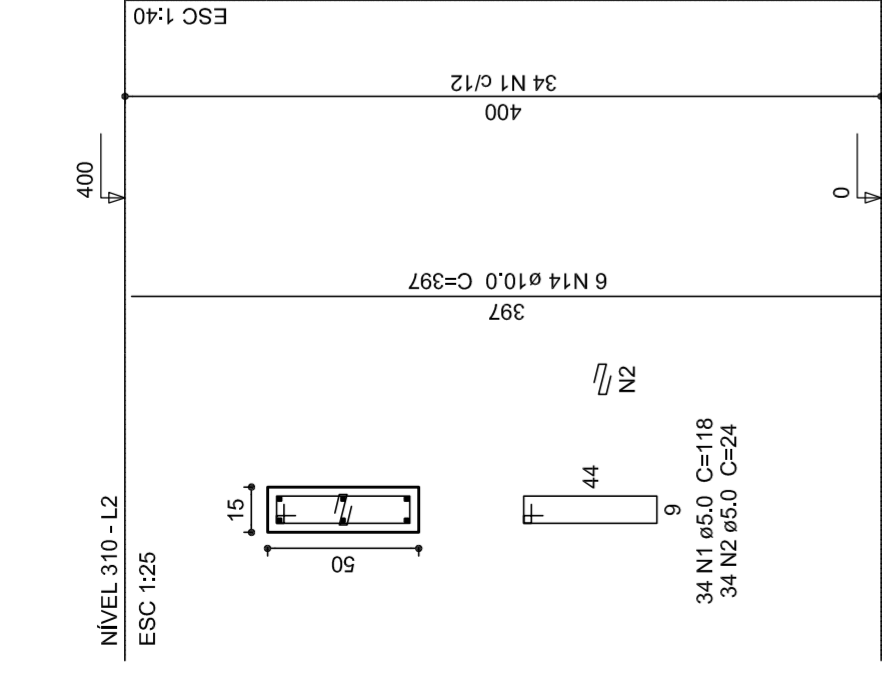

P33=P36

P37=P60

P58=P59

P62=P97

P67

P70

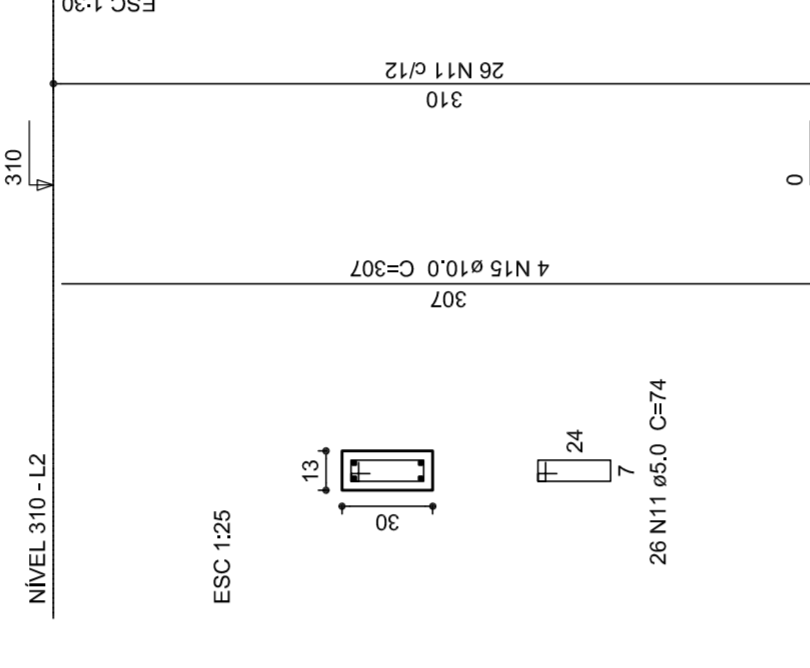
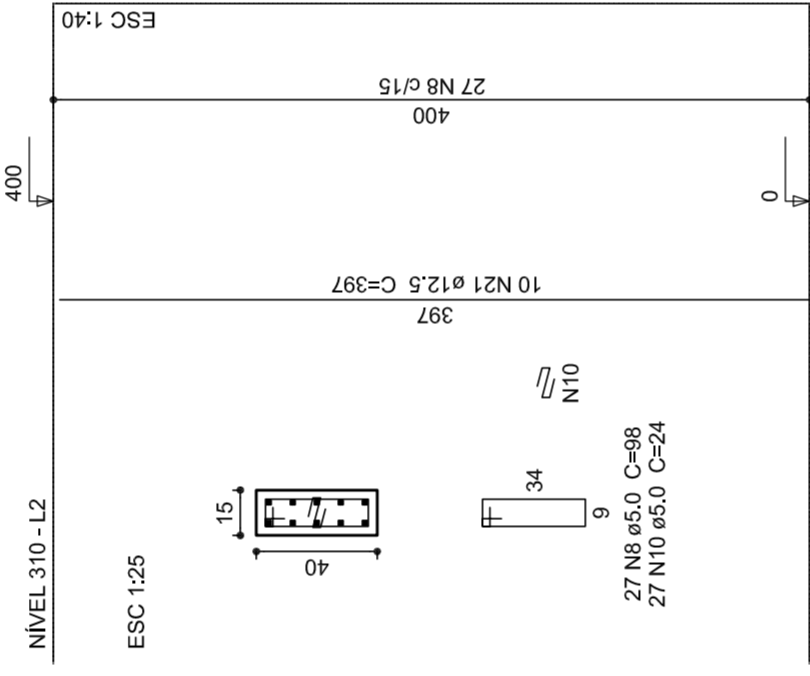
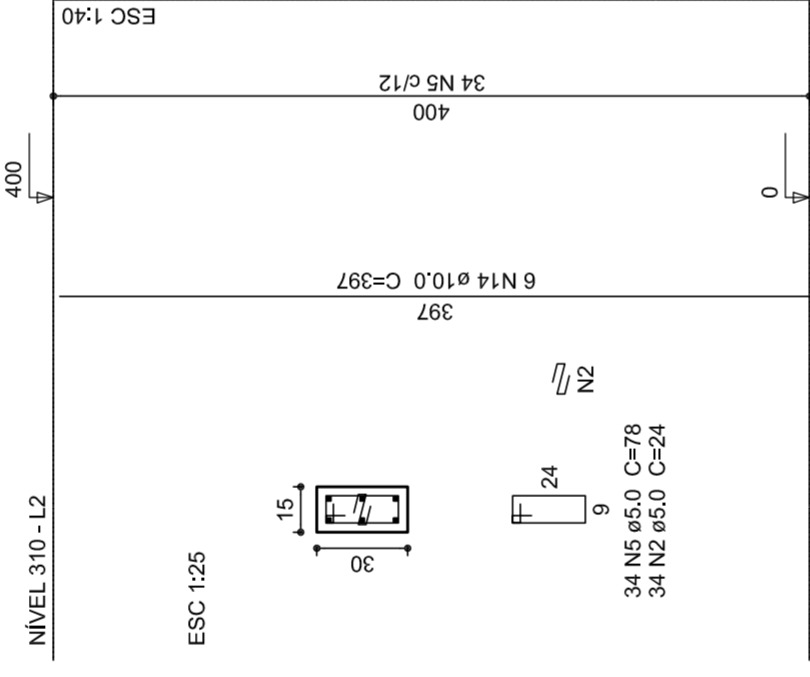
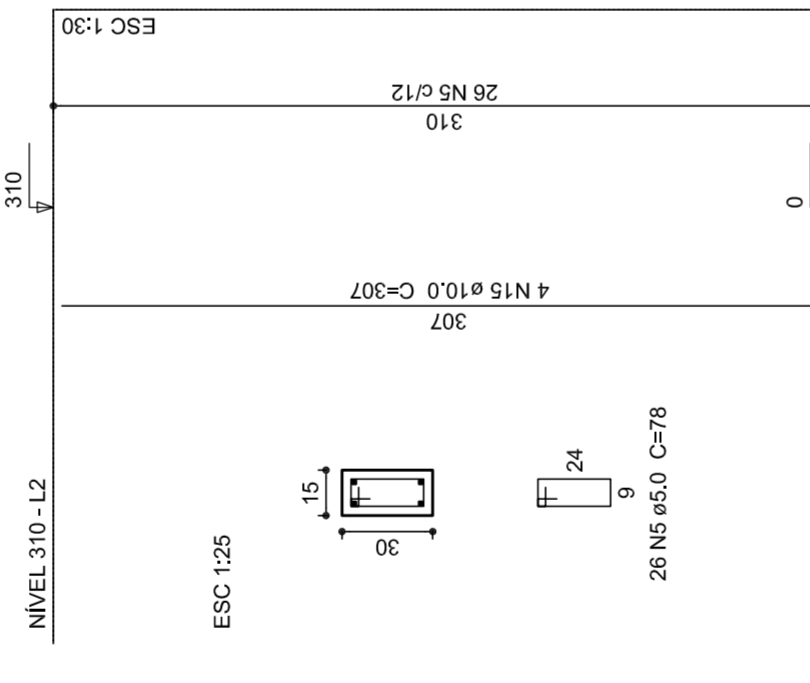
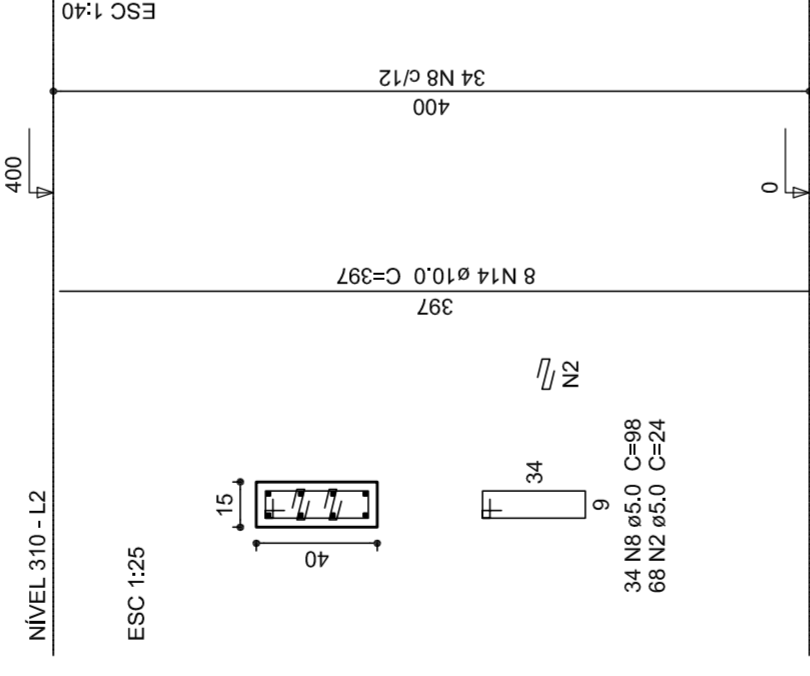
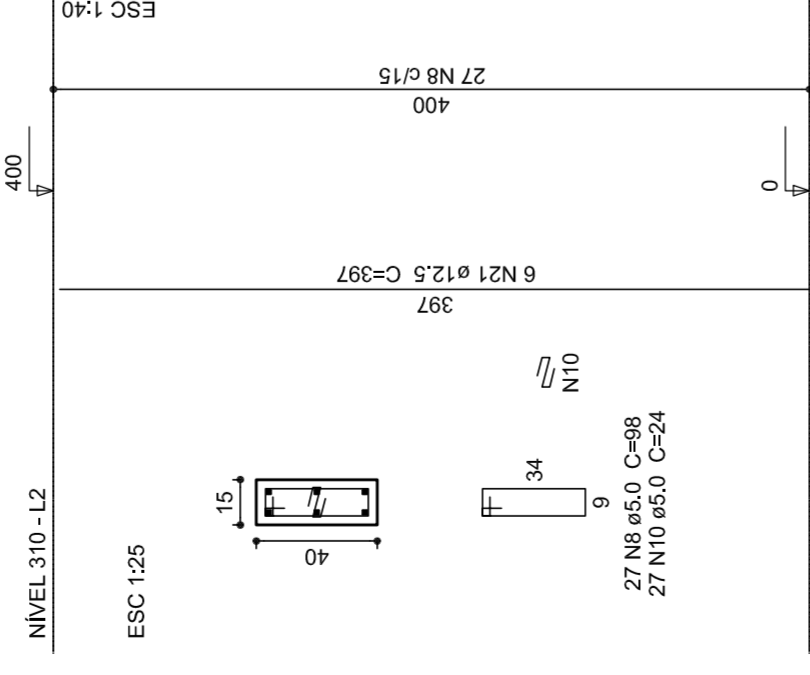

**Resumo do aço**

ACO	DIAM (mm)	C.TOTAL (m)	PESO + 10% (kg)
CA50	10,0	1826,7	1238,8
CA60	5,0	4920,6	691,8
<b>PESO TOTAL (kg)</b>			<b>1930,6</b>
CA50			1903,6
CA60			691,8

Volume de concreto (C=5) = 25,16 m³  
 Área da forma = 492,27 m²

P73

P86

P9=P16=P17=P40=P57=P66=P68=P76=P89=P106

P91=P99

P95=P96

P98

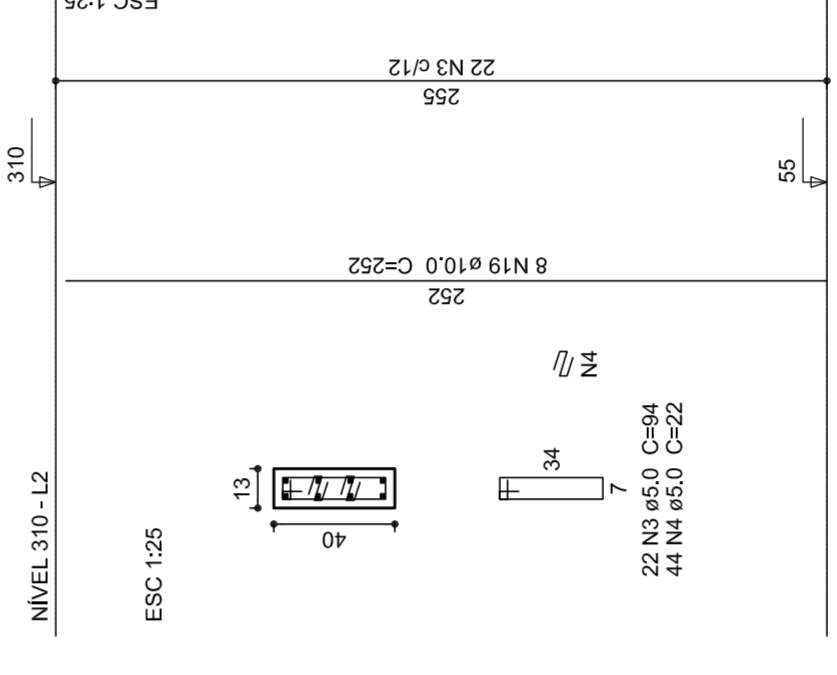
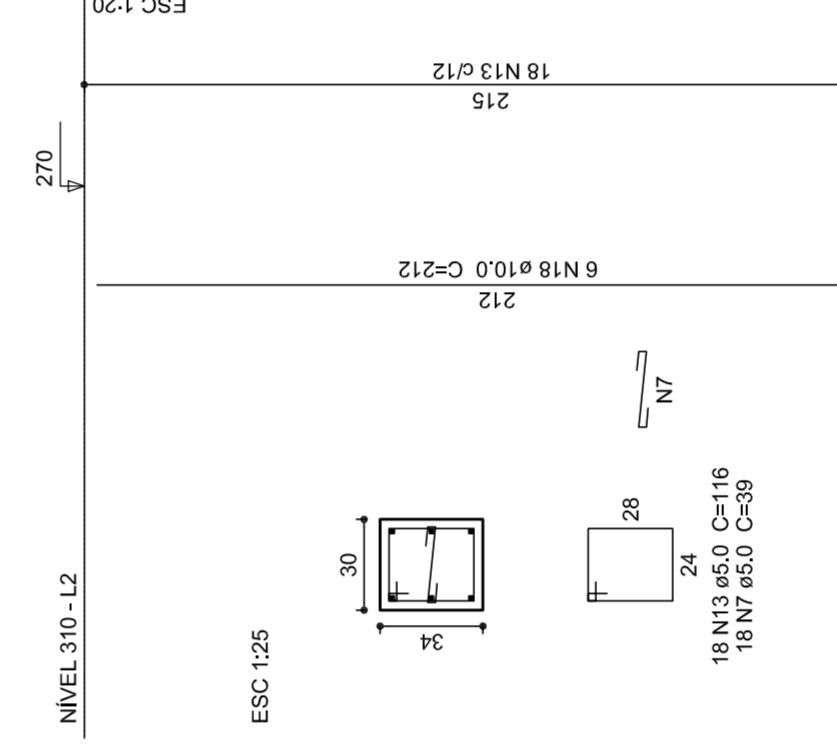
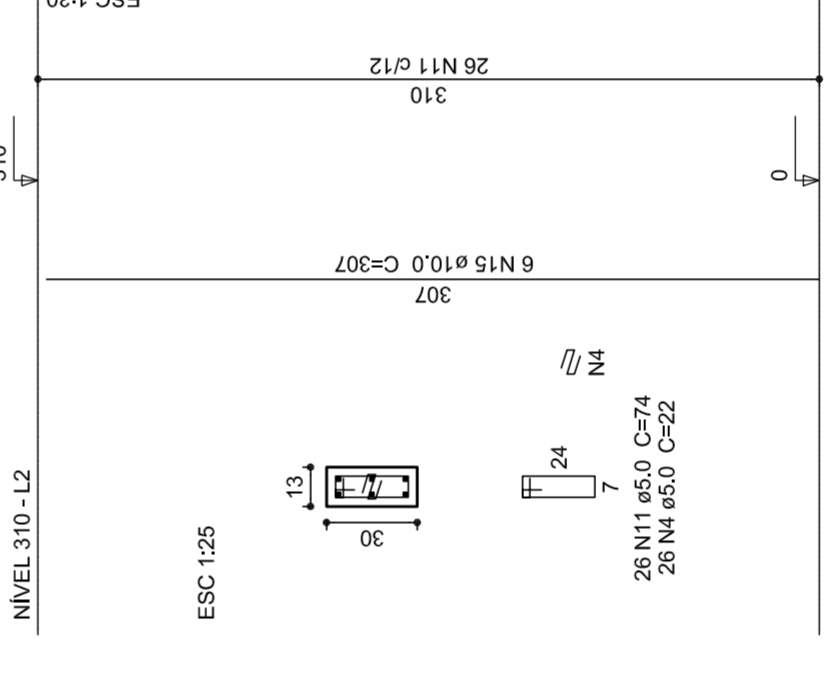
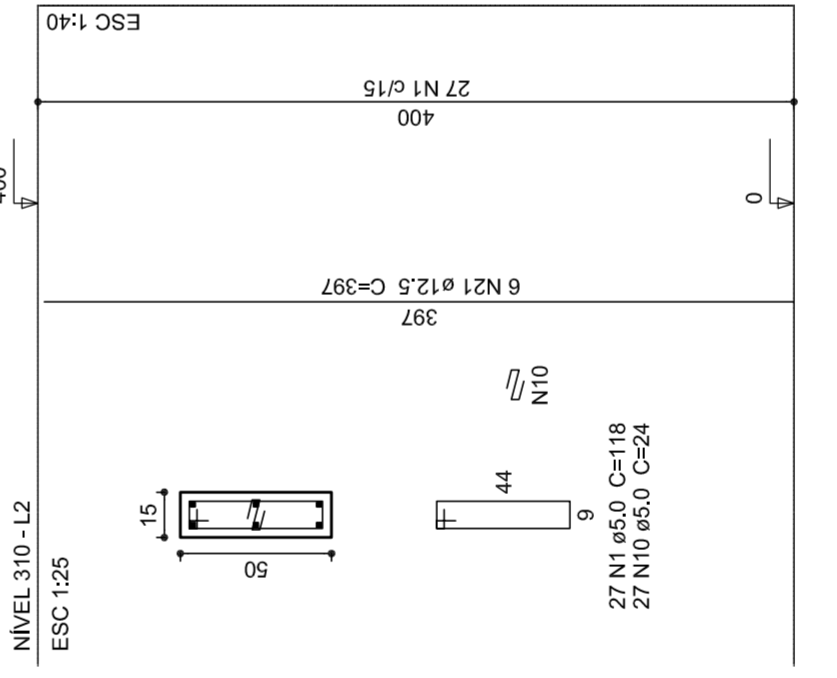
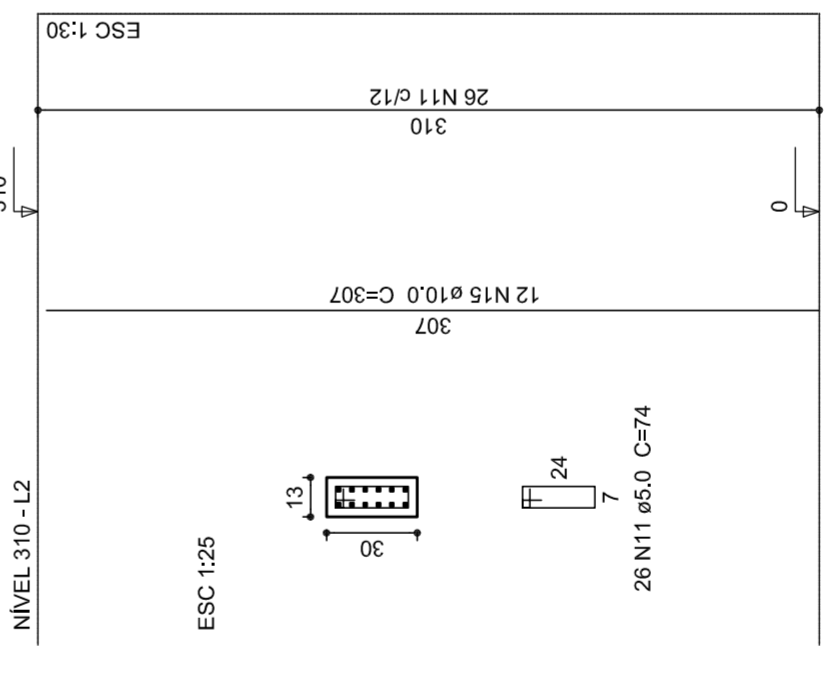
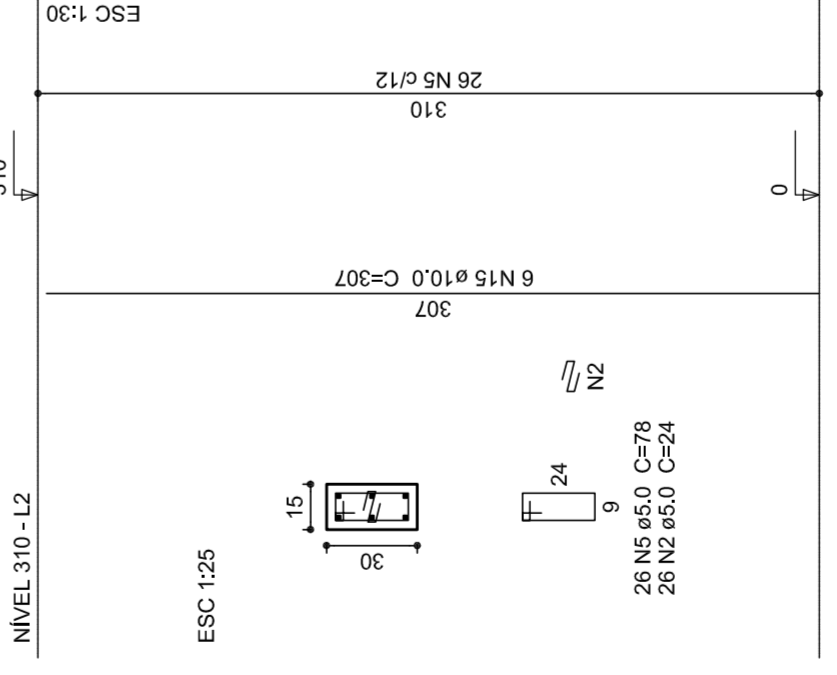
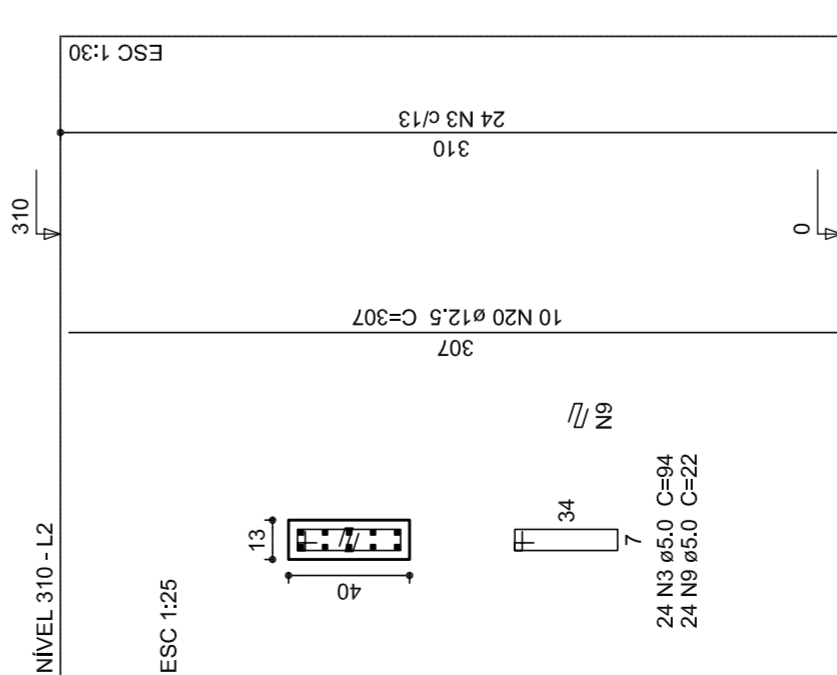

P72

P24=P25=P32=P78

P29

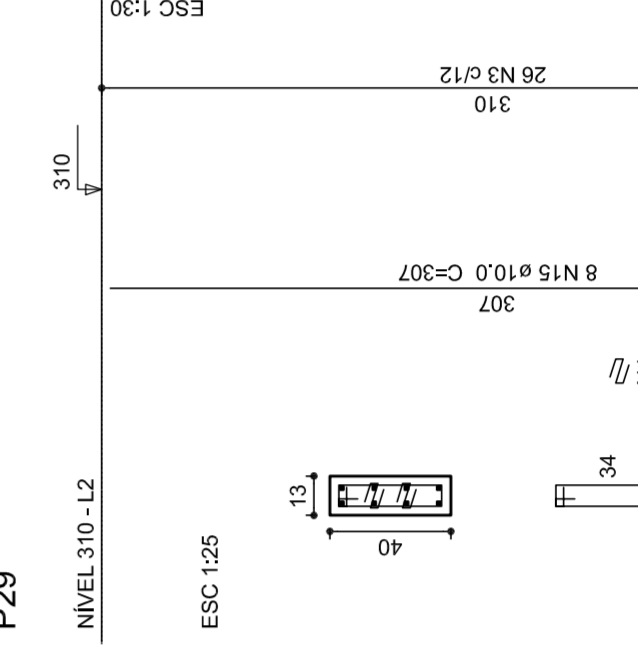
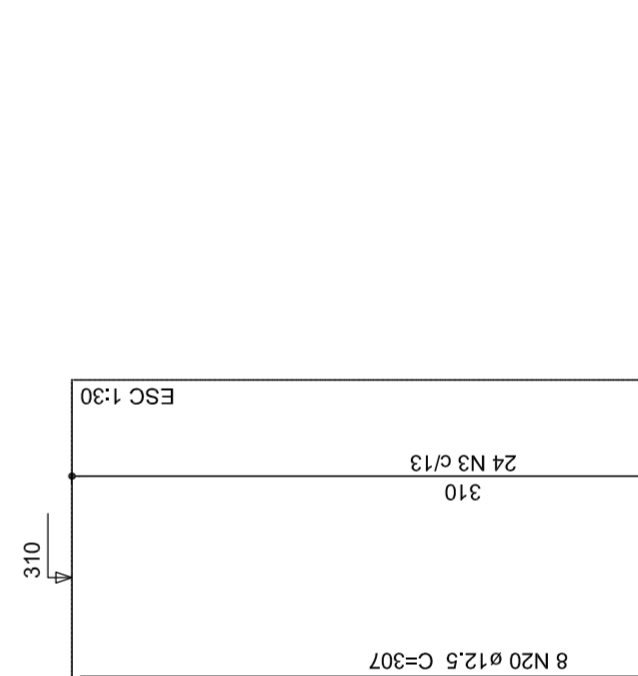
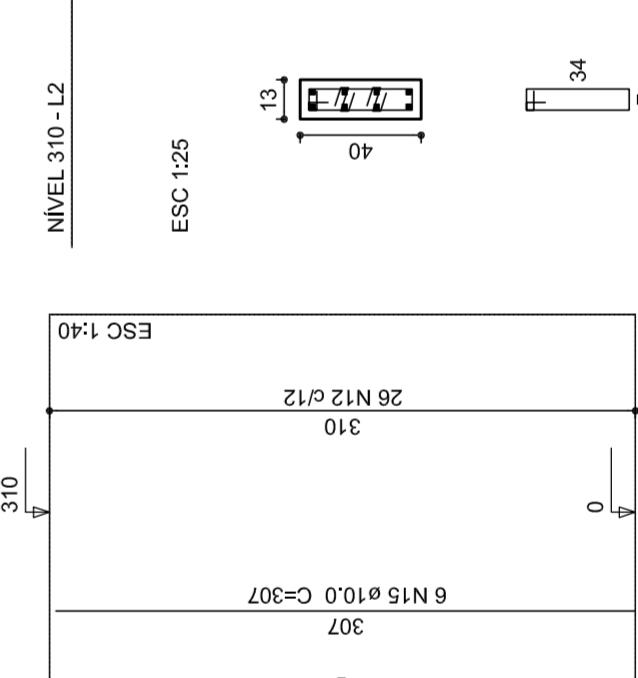
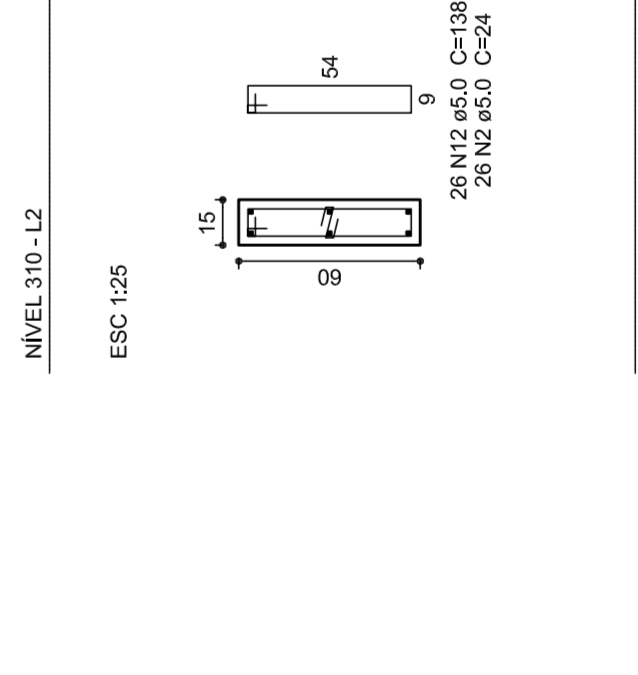

1 PILARES  
 ESCALA: INDICADA

PROJETO EXECUTIVO

PROGRAMA PROINFANCIA - PROJETO TIPO 1

PROJETO DE ESTRUTURA

PILARES

PROJETO DE ESTRUTURA

SCP

REVISÃO  
R. 00

FRANCHA  
12/16

ESCALA: INDICADA  
DATA: 09/04/2015  
JUNHO/2015

FORMATO (84x110)